

QUASAR

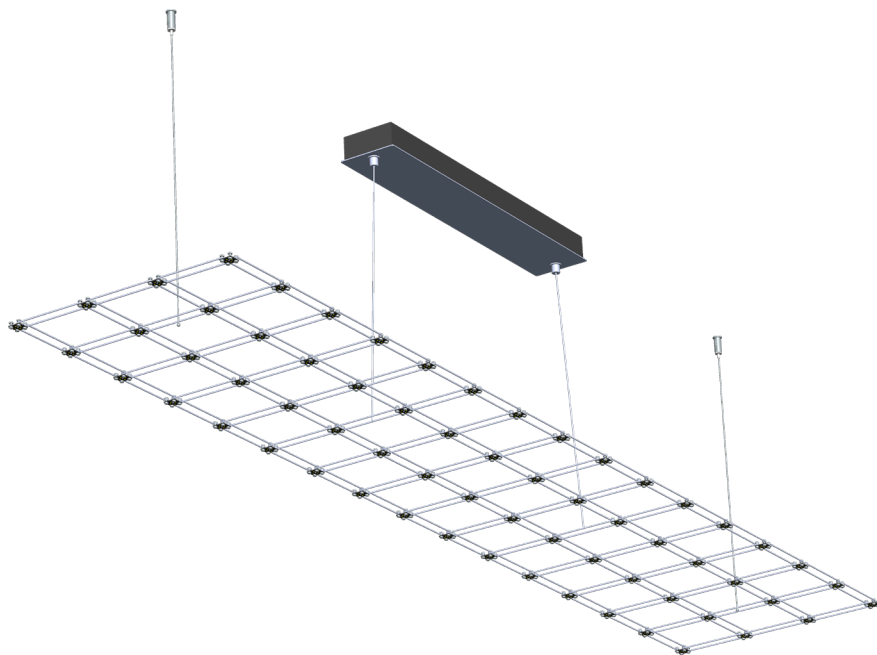

FRAME SUSPENSION

NL Installatie handleiding
DE Installationsanleitung
EN Installation manual

NL - INFORMATIE

Veiligheidsinformatie

- Onderbreek altijd de stroomtoevoer door de stekker uit de wandcontactdoos te halen, onderhoudswerk en het verwisselen van de lichtbronnen.
- Een brandende lamp is heet. Let op brandgevaar.
- De lamp mag niet op geleidend materiaal worden gemonteerd.
- Draag geen sieraden bij onderhoudswerkzaamheden.
- Geen (decoratie) materialen aan het armatuur bevestigen.

Technische informatie

- Ingangsspanning 120V of 240V
- Uitgangsspanning 12V
- Beschermingsklasse I
- Beschermingsgraad IP20
- De lamp mag niet in openlucht gebruikt worden.
- LED: 12V, 1.2W, 2800K
- Ten minste een afstand van 0,5m tenopzichte van het bestraalde oppervlakte houden.
- Technische gelijkvormigheid volgend EN-Richtlijnen

Onderhoudsinformatie

- Tijdens het schoonmaken van het armatuur dient de lamp ten alle tijde uitgeschakeld te zijn.
- De lampen reinigen met in de handel verkrijgbare, niet-agressieve en niet-schurende reinigingsmiddelen.
- Gebruik een plumeau.

DE - INFORMATION

Sicherheitshinweise

- Bei Montage, Wartungsarbeiten und Leuchtmittelwechsel immer Stromzufuhr unterbrechen.
- Wenn die Leuchte in Betrieb ist, besteht beim Glühmittel Verbrennungsgefahr!
- Leuchte darf nicht auf leitende Materialien montiert werden.
- Keine Juwelen während Wartung tragen.
- Keine (dekoration) Materialien an die Leuchte befestigen.

Technische Hinweise

- Eingangsspannung 120V oder 240V
- Ausgangsspannung 12V
- Schutzklasse I
- Schutzart IP20
- Leuchte darf nicht im Freien verwendet werden.
- LED: 12V, 1.2W, 2800K
- Mindestabstand zur angestrahlten Fläche 0,5m
- Technische Konformität gemäss EU-Richtlinien

Pflegehinweise

- Während der Reinigung der Leuchte muss die Lampe immer ausgeschaltet sein.
 - Leuchten nur mit handelsüblichen, nicht aggressiven und scheuernden Reinigungsmitteln reinigen.
 - Gebrauch eine Federbesen.
-

EN - INFORMATION

Safety information

- During installation, maintenance work and change of bulbs/leds always interrupt the power supply.
- When switched on, the lamp may cause burns when touched.
- Lamp may not be mounted on conductive materials.
- Don't wear jewelry during maintenance.
- Don't use decoration materials in the lamp.

Technical data

- Input voltage 120V or 240V
- Output voltage 12V
- Safety class I
- Degree of protection IP20
- Lamp must not be used in the open.
- LED: 12V, 1.2W, 2800K
- Minimum distance from illuminated surface 0.5m
- Technical conformity according to European EN-Regulations.

Maintenance information

- The lamp must be switched off at all times during cleaning of the luminaire.
- Lights should only be cleaned using commercially available, non-aggressive, non-scouring cleaning agents.
- Use a feather duster.

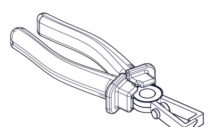
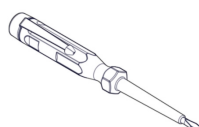
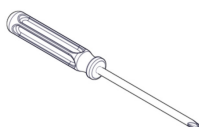
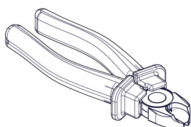
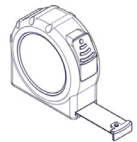
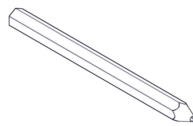
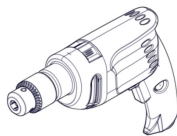
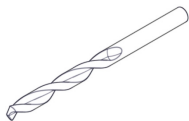

1

Frame 111

36X LED, 12V/1.2W = 43,2W

Frame 165

52X LED, 12V/1.2W = 62,4W

Frame ...

...X LED, 12V/0.33W = ...W

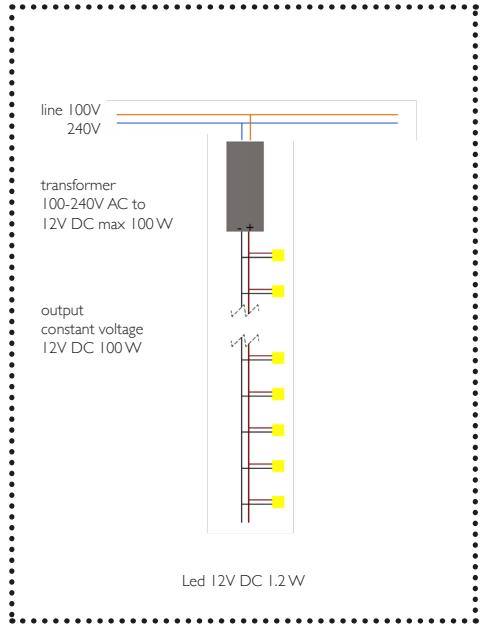

2

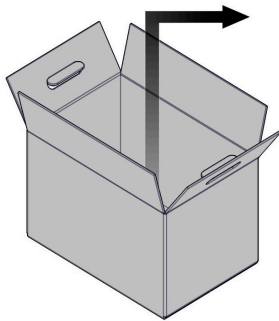

1

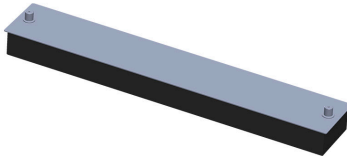

2

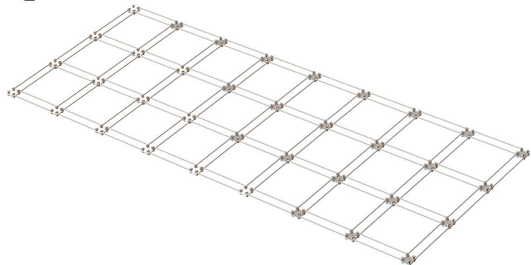

3



3

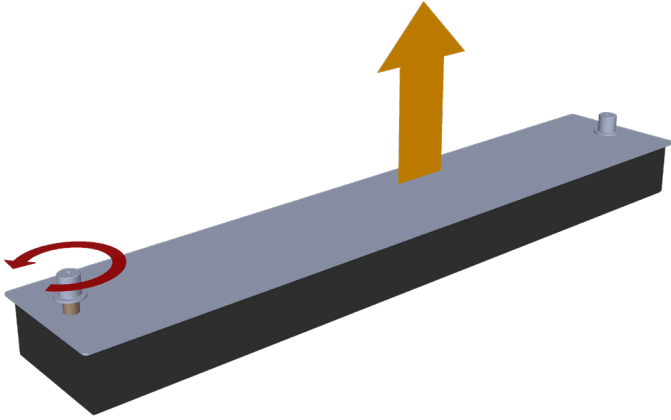

4

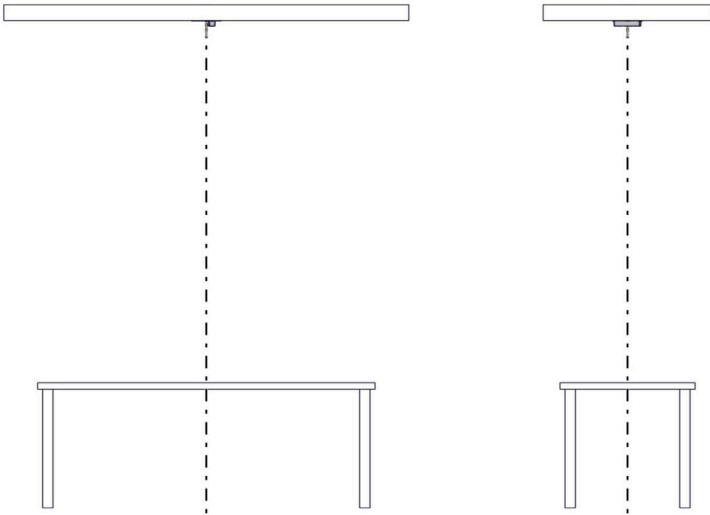

5

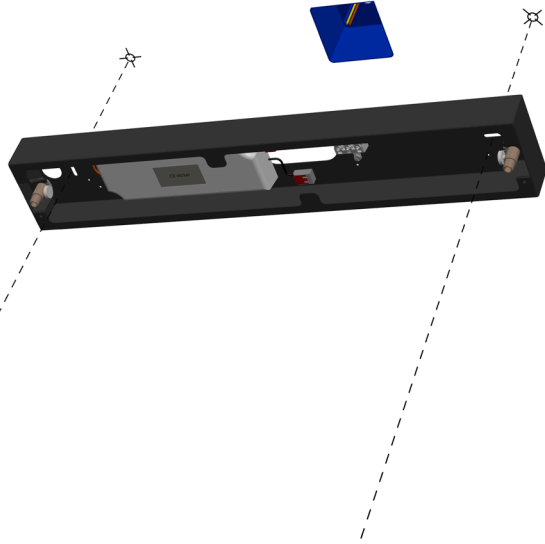
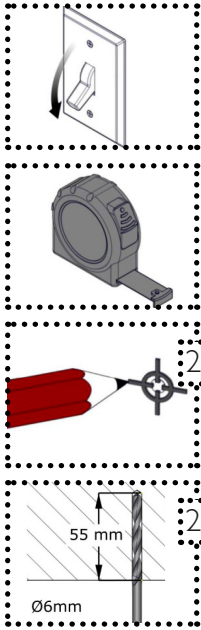

6

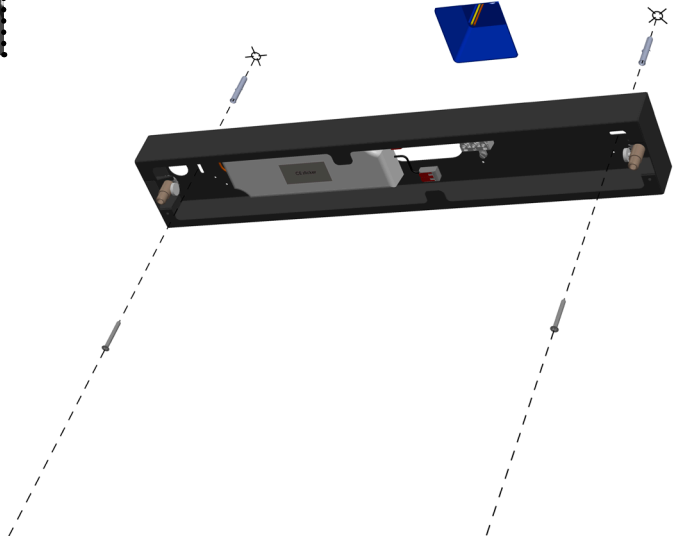
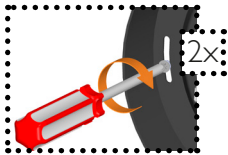

7

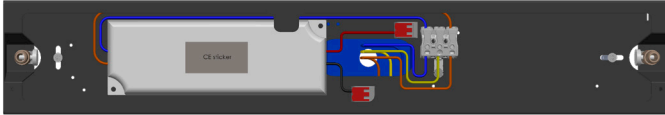
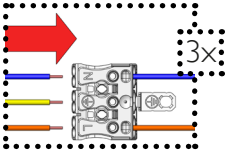

8

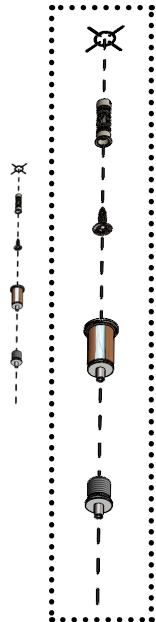
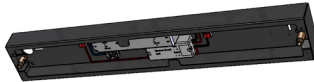

9

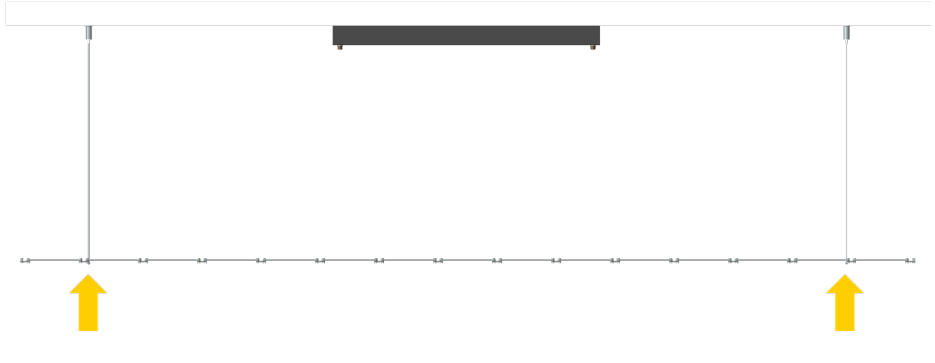
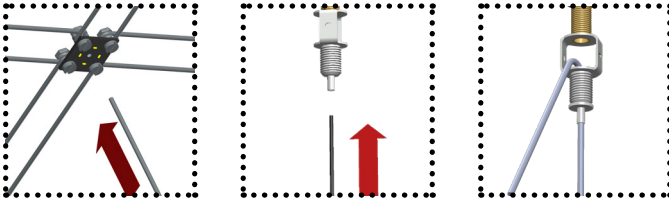

10

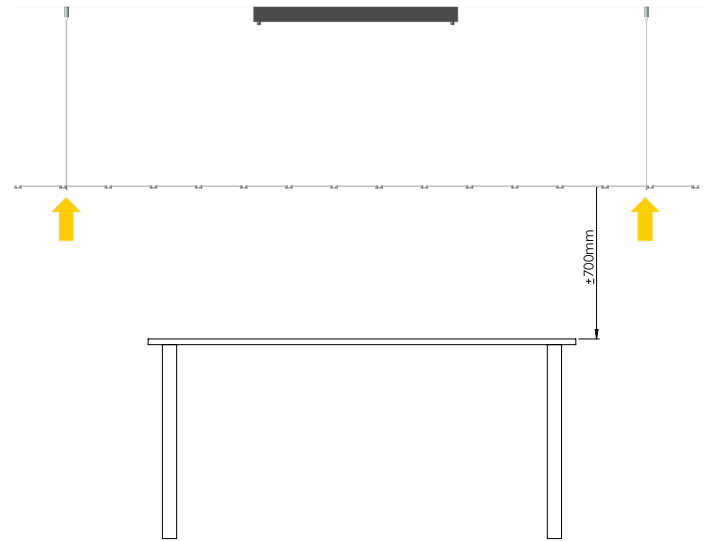
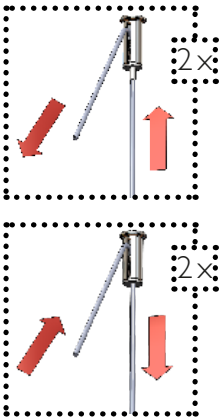

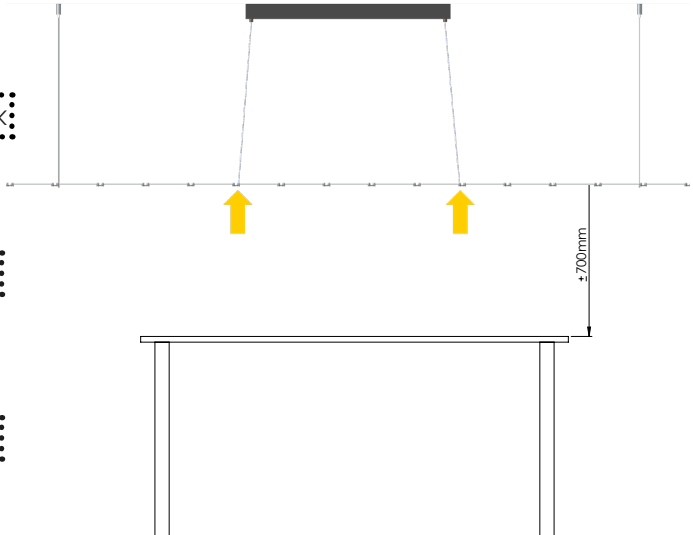
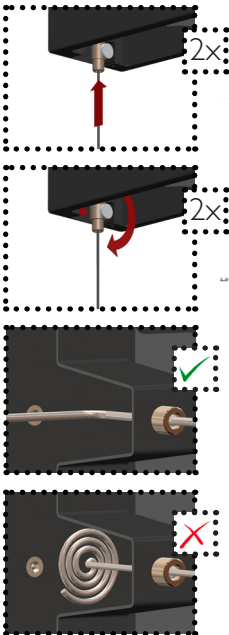
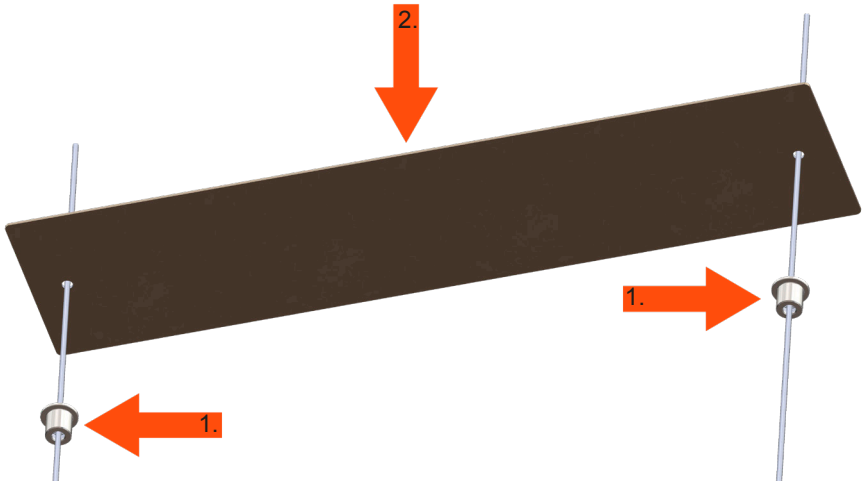

13

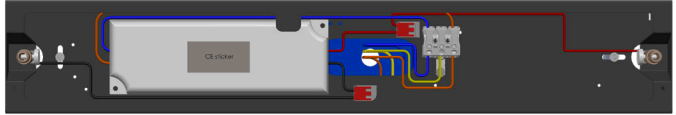
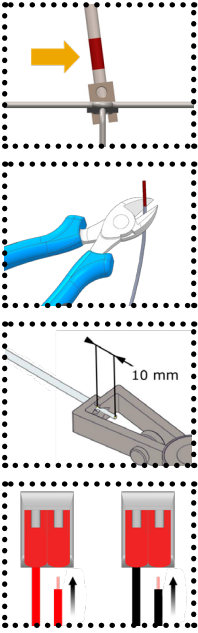

14

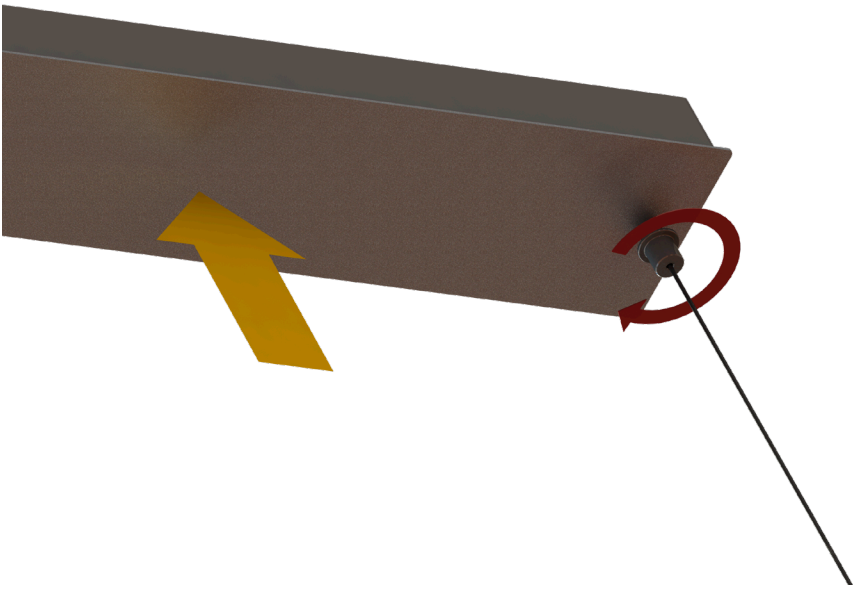

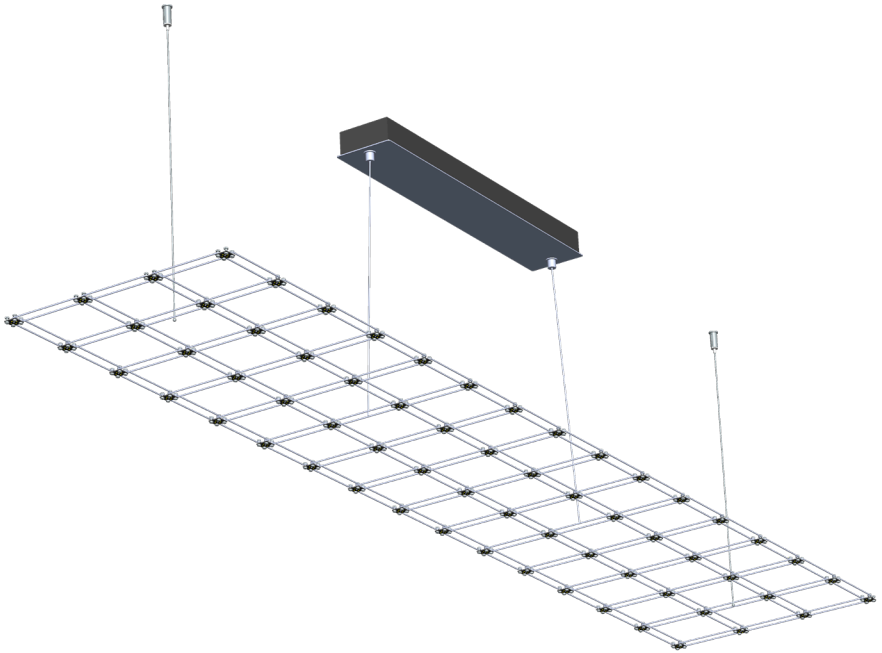
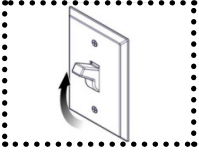

QUASAR

Burgstraat 2 4283 GG Giessen The Netherlands
+31-(0)183-447887
info@quasar.nl www.quasar.nl

Date: 20-07-2023

Version: 2