

# QUASAR



## ECLIPSE COMPOSITION

NL Installatie handleiding  
DE Installationsanleitung  
EN Installation manual

## NL - INFORMATIE

---

### Veiligheidsinformatie

- Onderbreek altijd de stroomtoevoer door de stekker uit de wandcontactdoos te halen, onderhoudswerk en het verwisselen van de lichtbronnen.
- Een brandende lamp is heet. Let op brandgevaar.
- De lamp mag niet op geleidend materiaal worden gemonteerd.
- Draag geen sieraden bij onderhoudswerkzaamheden.
- Geen (decoratie) materialen aan het armatuur bevestigen.

### Technische informatie

- Ingangsspanning 120V of 240V
- Uitgangsspanning 12V
- Beschermingsklasse I
- Beschermingsgraad IP20
- De lamp mag niet in openlucht gebruikt worden.
- LED: 12V, 0,6W, 2800K
- Ten minste een afstand van 0,5m tenopzichte van het bestraalde oppervlakte houden.
- Technische gelijkvormigheid volgend EN-Richtlijnen

### Onderhoudsinformatie

- Tijdens het schoonmaken van het armatuur dient de lamp ten alle tijde uitgeschakeld te zijn.
- De lampen reinigen met in de handel verkrijgbare, niet-agressieve en niet-schurende reinigingsmiddelen.
- Gebruik een plumeau.

---

## DE - INFORMATION

---

### Sicherheitshinweise

- Bei Montage, Wartungsarbeiten und Leuchtmittelwechsel immer Stromzufuhr unterbrechen.
- Wenn die Leuchte in Betrieb ist, besteht beim Glühmittel Verbrennungsgefahr!
- Leuchte darf nicht auf leitende Materialien montiert werden.
- Keine Juwelen während Wartung tragen.
- Keine (dekoration) Materialien an die Leuchte befestigen.

### Technische Hinweise

- Eingangsspannung 120V oder 240V
- Ausgangsspannung 12V
- Schutzklasse I
- Schutzart IP20
- Leuchte darf nicht im Freien verwendet werden.
- LED: 12V, 0,6W, 2800K
- Mindestabstand zur angestrahlten Fläche 0,5m
- Technische Konformität gemäss EU-Richtlinien

### Pflegehinweise

- Während der Reinigung der Leuchte muss die Lampe immer ausgeschaltet sein.
  - Leuchten nur mit handelsüblichen, nicht aggressiven und scheuernden Reinigungsmitteln reinigen.
  - Gebrauch eine Federbesen.
-

## EN - INFORMATION

---

### Safety information

- During installation, maintenance work and change of bulbs/leds always interrupt the power supply.
- When switched on, the lamp may cause burns when touched.
- Lamp may not be mounted on conductive materials.
- Don't wear jewelry during maintenance.
- Don't use decoration materials in the lamp.

### Technical data

- Input voltage 120V or 240V
- Output voltage 12V
- Safety class I
- Degree of protection IP20
- Lamp must not be used in the open.
- LED: 12V, 0.6W, 2800K
- Minimum distance from illuminated surface 0.5m
- Technical conformity according to European EN-Regulations.

### Maintenance information

- The lamp must be switched off at all times during cleaning of the luminaire.
- Lights should only be cleaned using commercially available, non-aggressive, non-scouring cleaning agents.
- Use a feather duster.

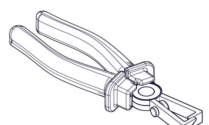
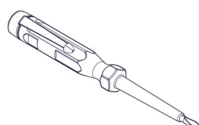
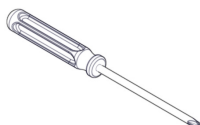
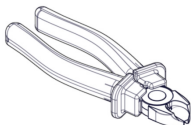
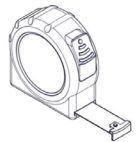
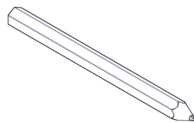
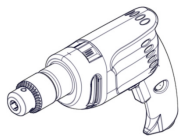
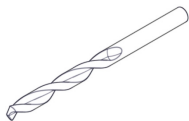

1

**D = 68CM**

44X LED E10, 12V/0.6W = 26,4W

**D = 83CM**

52X LED E10, 12V/0.6W = 31,2W

**D = 96CM**

60X LED E10, 12V/0.6W = 36W

**D = 118CM**

75X LED E10, 12V/0.6W = 45W

**D = 140CM**

88X LED E10, 12V/0.6W = 52,8W

**D = 160CM**

100X LED E10, 12V/0.6W = 60W

**D = 180CM**

113X LED E10, 12V/0.6W = 67,8W

**D = 200CM**

126X LED E10, 12V/0.6W = 75,6W

**D = ...CM**

...X LED E10, 12V/0.6W = ...W

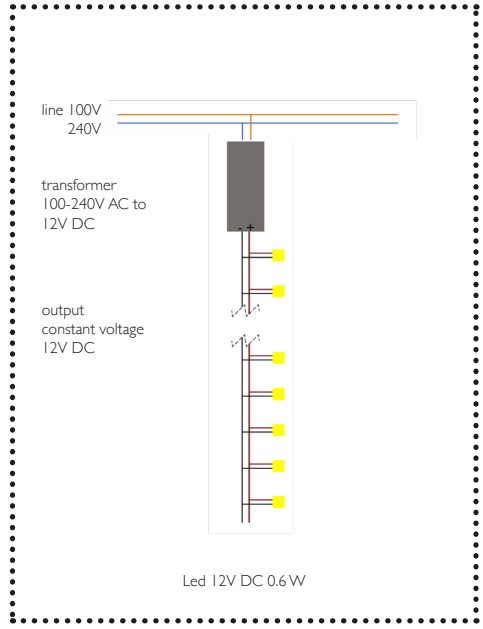

2

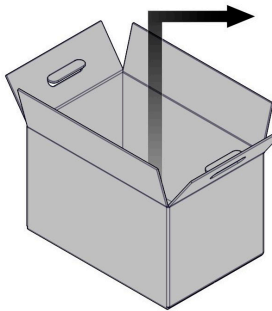

1.

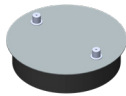

2.

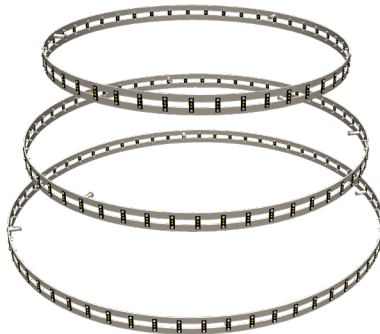

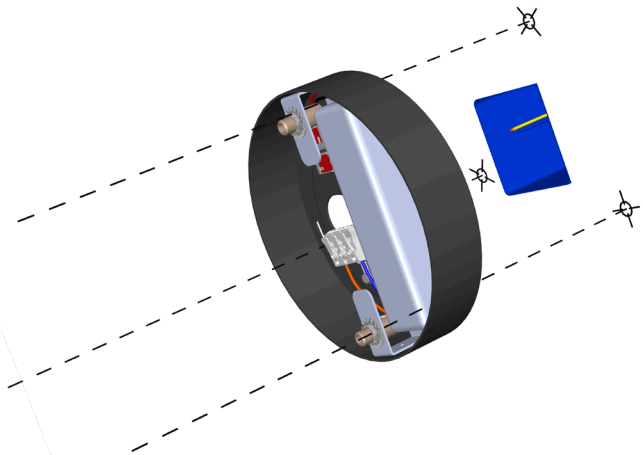
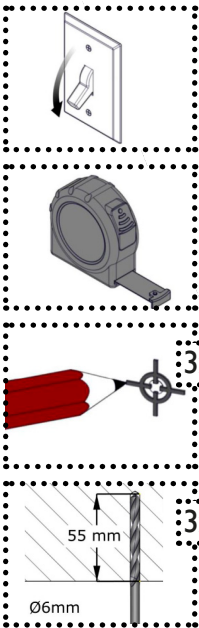
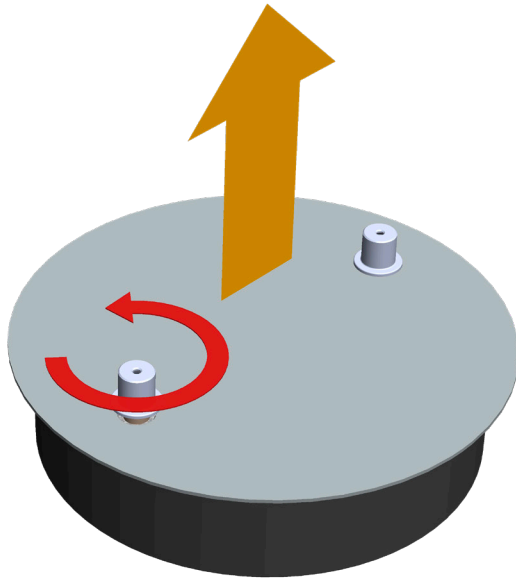

5

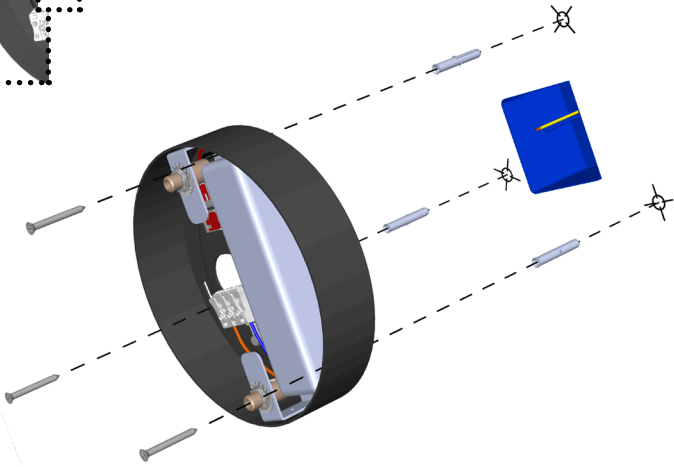
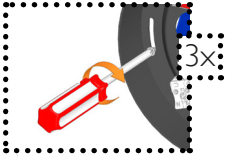

6

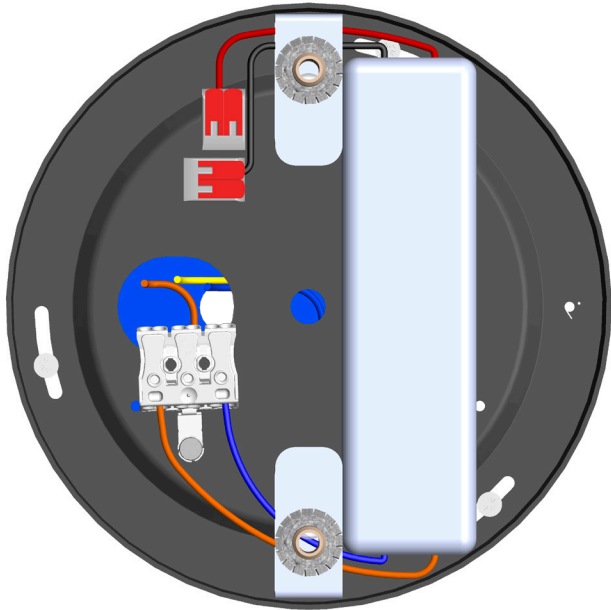
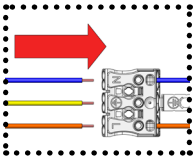

7

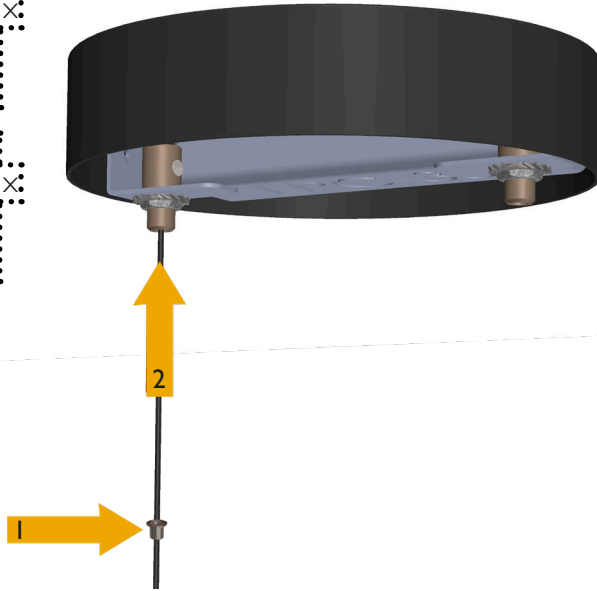
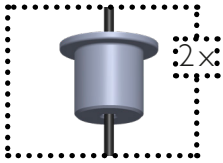

8

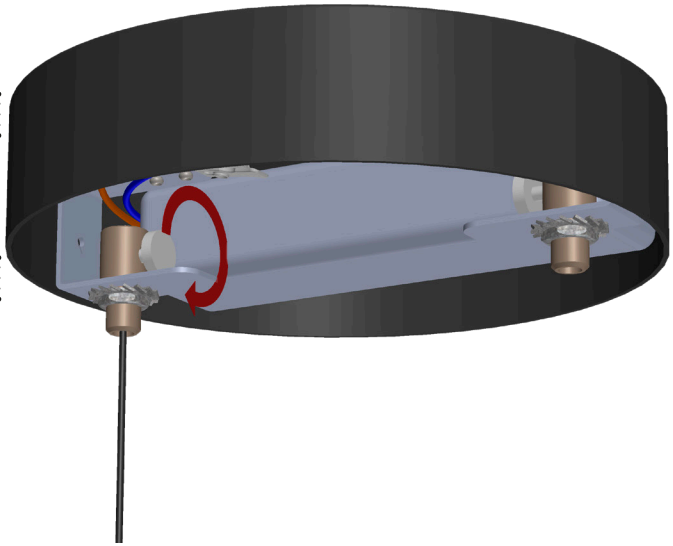
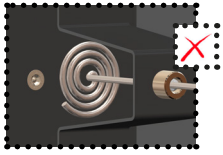
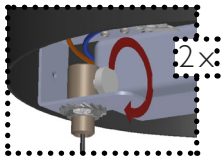

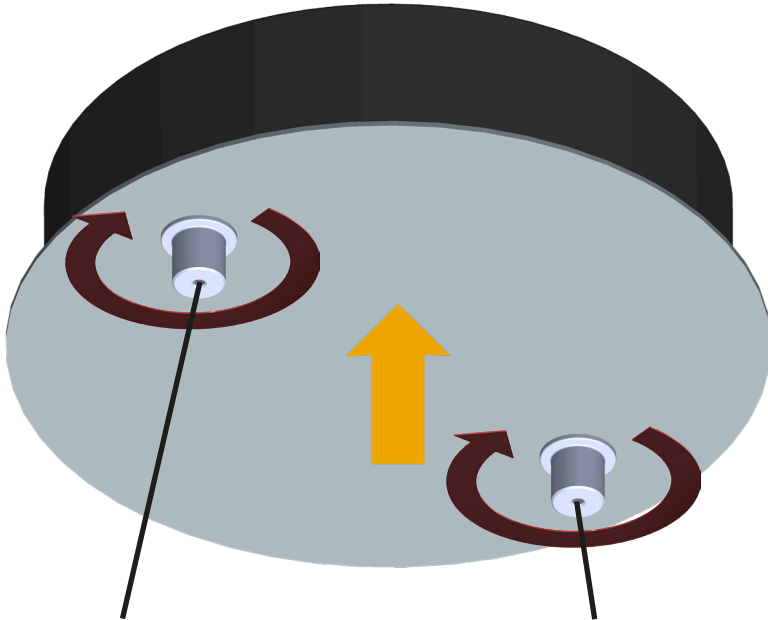
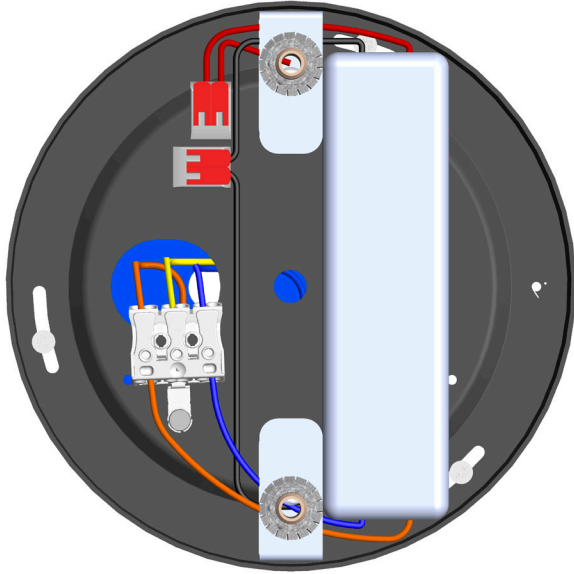
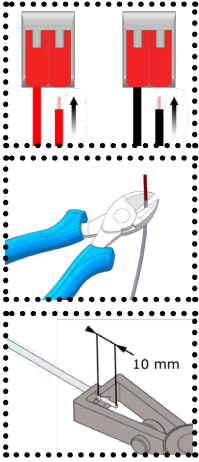



11

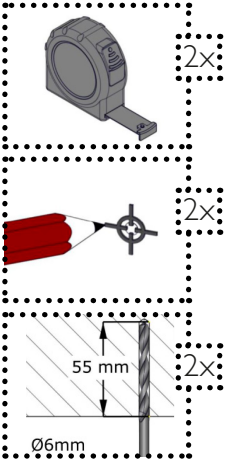

Ø depending on chosen Eclipse ring

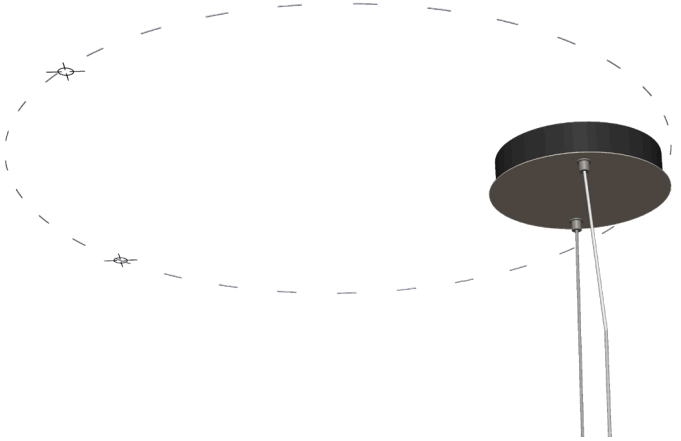

12

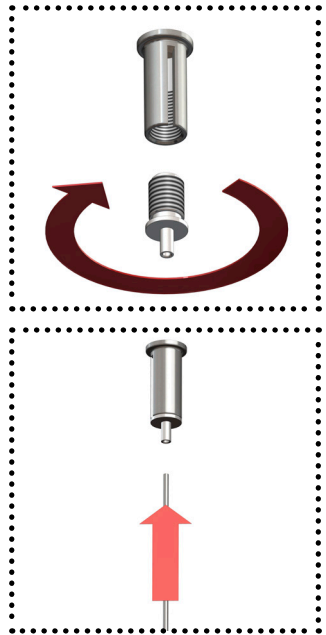
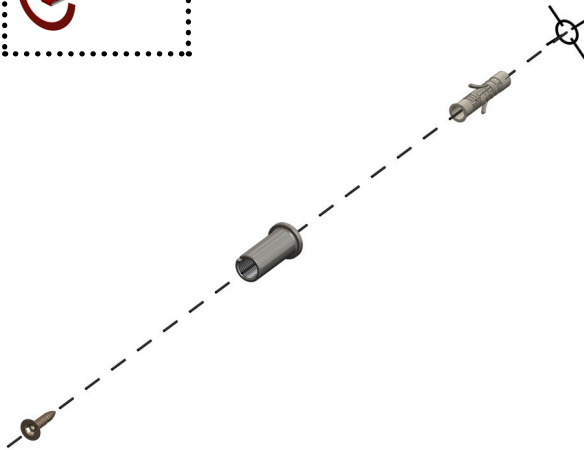

13

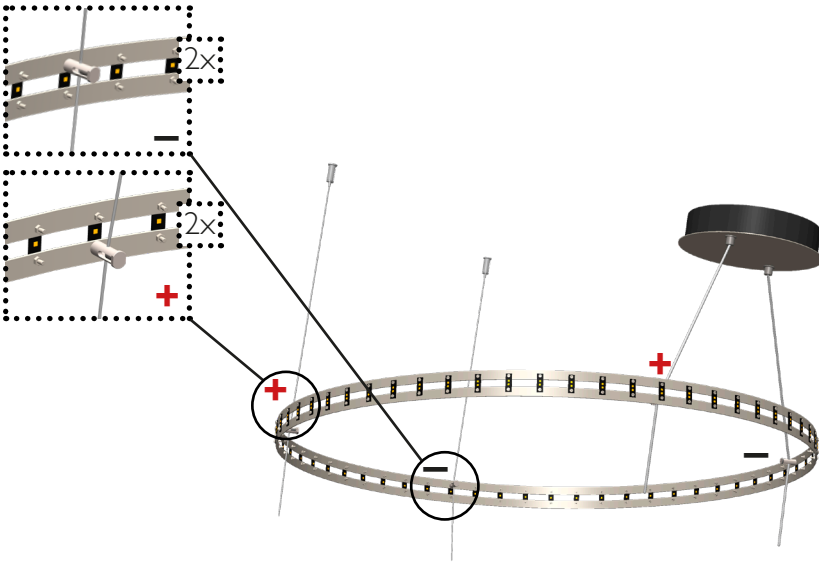

14

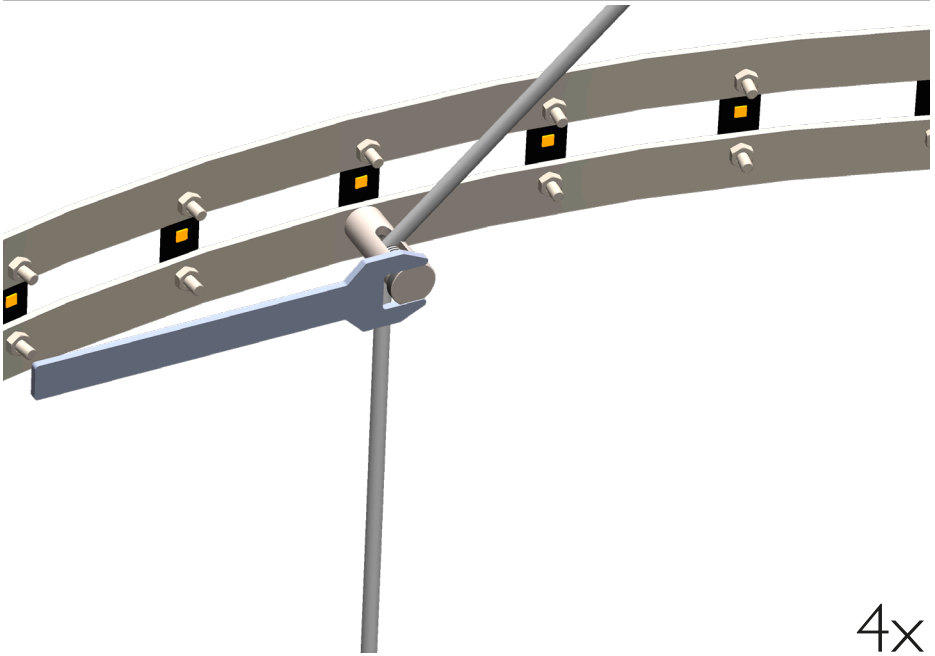

4x

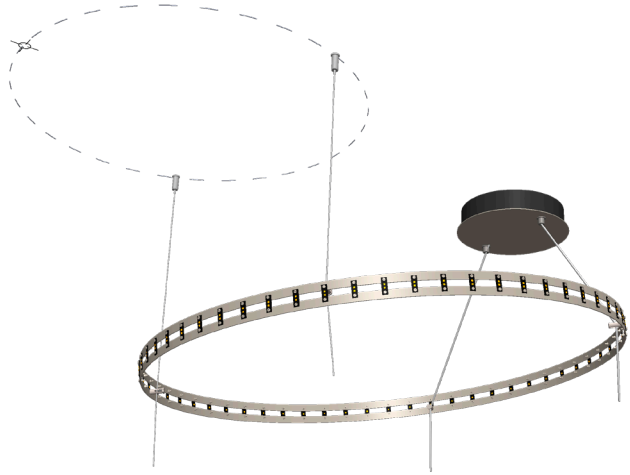
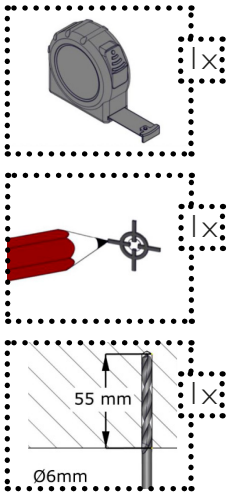

Ø depending on  
chosen Eclipse ring

4x



Repeat step 12 > 14

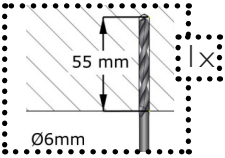
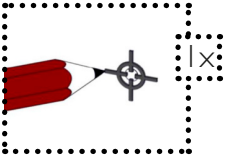
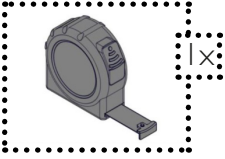

Ø depending on  
chosen Eclipse ring

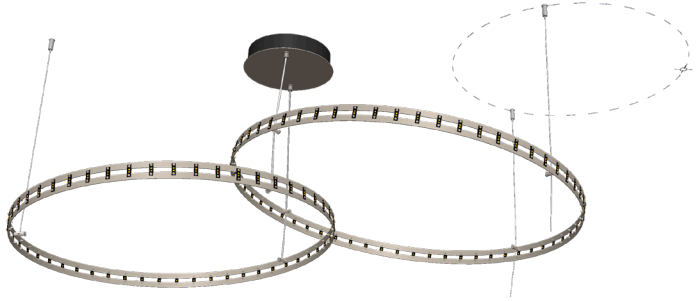

Repeat step 12 > 14

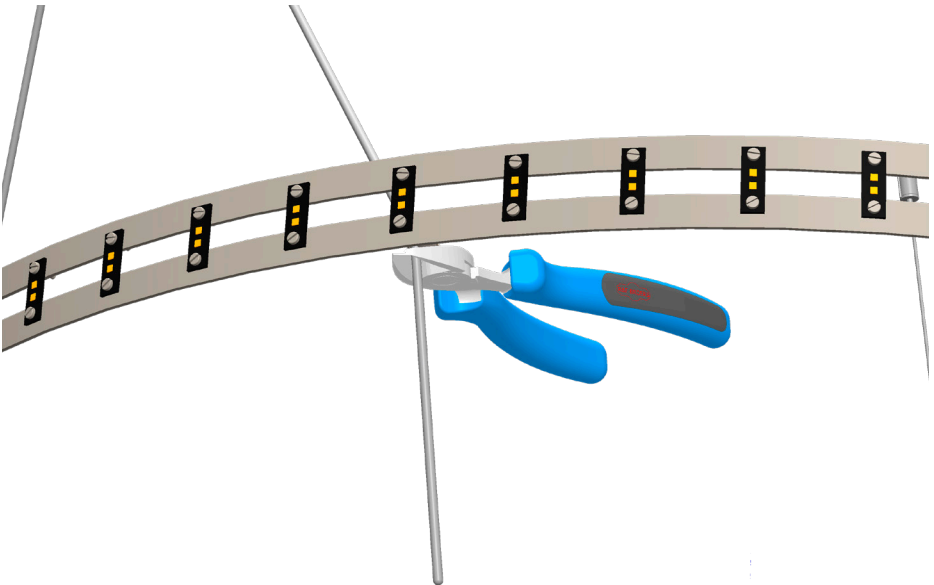
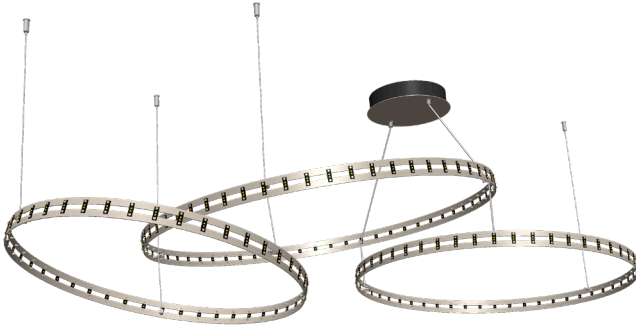
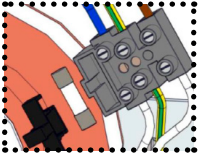

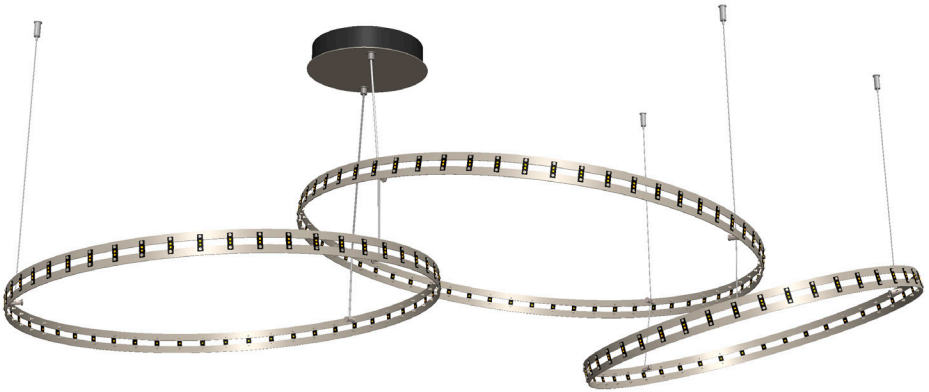
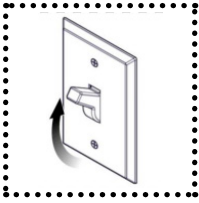

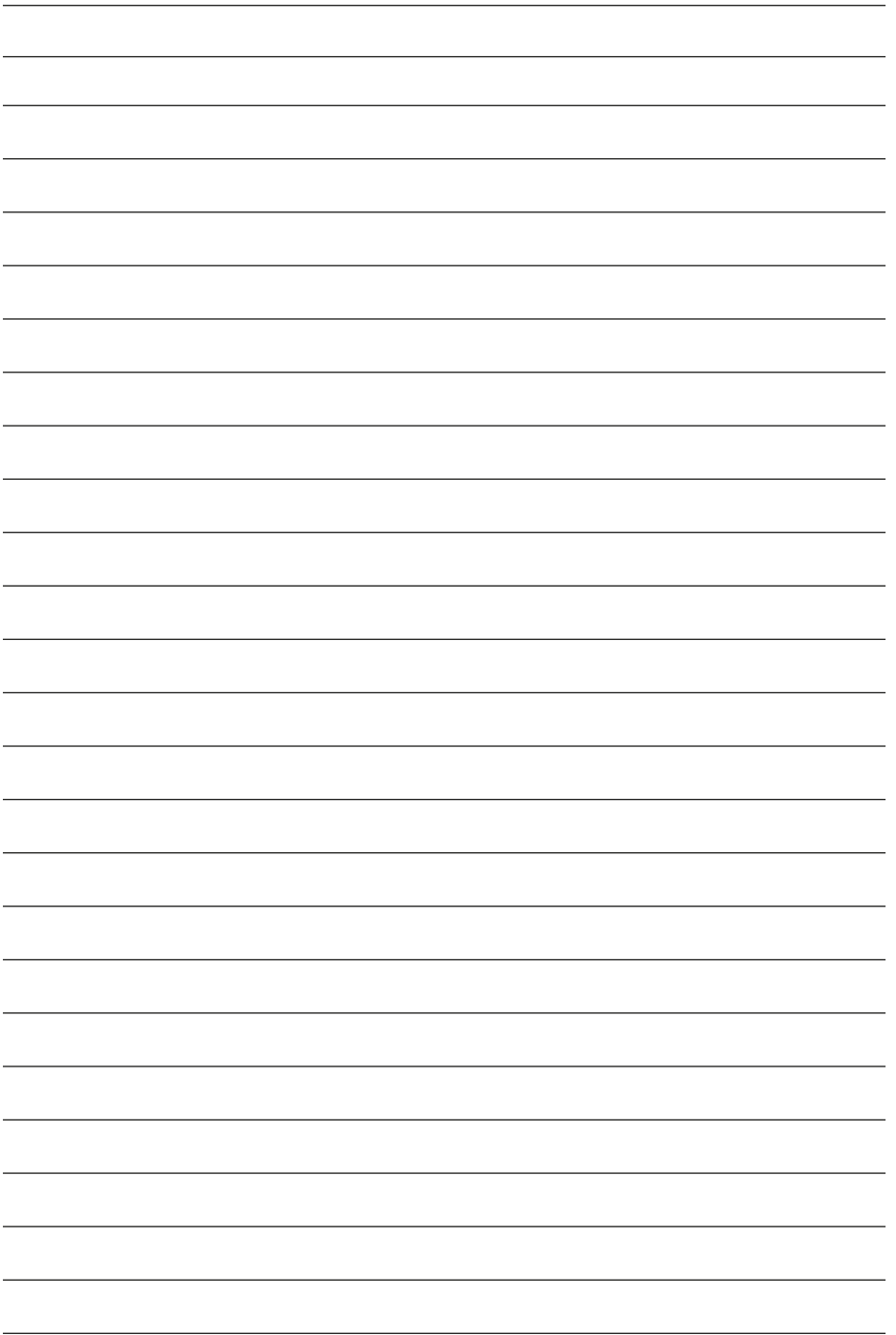

# QUASAR

Burgstraat 2 4283 GG Giessen The Netherlands  
+31-(0)183-447887  
info@quasar.nl www.quasar.nl

Date: 16-05-2023

Version: 3